

FORWARD



Forward Family

Small Device Mounting & Cable Management

Pop and twist to install your cable management accessories and small device mounting clamps into anywhere the patented universal hole pattern is located without any hardware

FEATURES

- Pop, twist, push, done. Secure your small, non-rackmount devices to any place the patented universal hole pattern is found. Simply pop the clamp into slot, twist to lock it in place and push the clamp down.
- Limitless cable routing. The new Forward cable management products give you the flexibility you need to get your cables from Point A to Point B with C Rings, D Rings and Tie saddles.
- Forward Small Device Stop Brackets help secure devices placed on a shelf from being pushed back into the rack if a button is pushed on the face of the device.
- The bold blue finish not only looks cool, but it also helps you identify where your cable management accessories and small device mounting clamps are located in a fully loaded enclosure for any future adds, moves or changes.
- Made from durable nylon, these products will hold up to your cable intensive systems and small device mounting needs.



FORWARD



Forward Family

Small Device Mounting
& Cable Management

SPECIFICATIONS

Forward Family small device mounting clamps shall be Middle Atlantic Products model # FWD-SIDECLMP-X and include X pieces (X =4, 24 or 60). Forward Family small device mounting shall be made from blue nylon, mount to .22"x.48" obrounds, mount in a tool-free manner, and have a clamping range of .5" to 2.05" Forward Family small device mounting shall be manufactured by an ISO 9001 and ISO 14001 registered company. Forward Family small device mounting shall be warranted to be free from defects in material or workmanship under normal use and conditions for the lifetime of the product.

Forward Family cable management accessories shall be Middle Atlantic Products model # FWD-___ and include ___ piece(s) (1 or 12 for D-Ring; 1, 12 or 36 for C-Ring; 15 or 48 for Tie Saddles). Forward Family small device mounting shall be made from blue nylon, and mount in a tool-free manner. Forward Family cable management accessories shall be ___"H x ___"W x ___"D"(refer to drawing.) Forward Family cable management accessories shall be manufactured by an ISO 9001 and ISO 14001 registered company. Forward Family cable management accessories shall be warranted to be free from defects in material or workmanship under normal use and conditions for the lifetime of the product.



EIA/TIA COMPLIANT



Forward Family

Small Device Mounting & Cable Management

NOTE(S):
1. ALL DIMENSIONS SHOWN IN FORMAT:
INCHES [MILLIMETERS]
2. WEIGHT CAPACITY: 5 LB / EACH

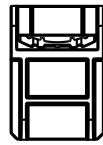

TOP VIEW

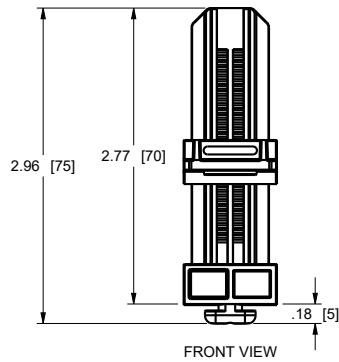

FRONT VIEW

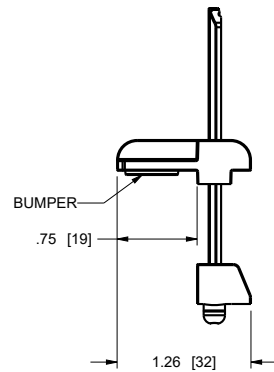

BUMPER
.75 [19]

SIDE VIEW

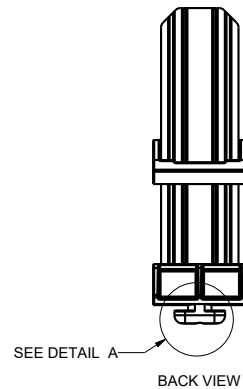

BACK VIEW

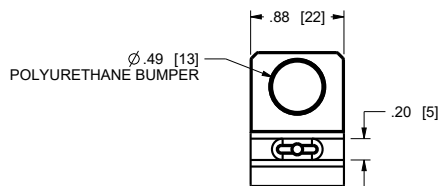

BOTTOM VIEW

ALL SMALL DEVICE MOUNTING AND
CABLE MANAGEMENT SOLUTIONS FIT IN
0.22 [6] X 0.48 [12] (MIN) OBROUND

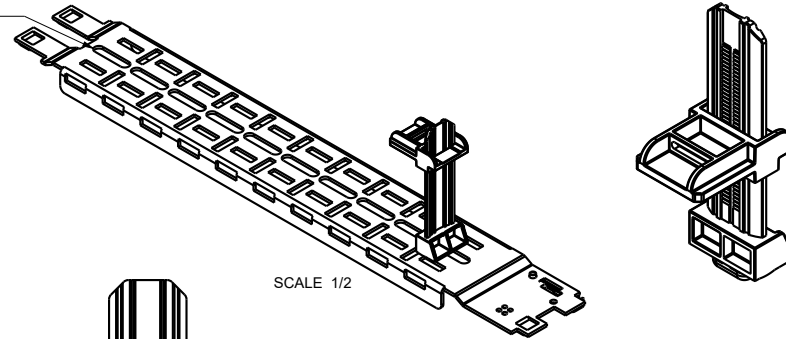

SCALE 1/2

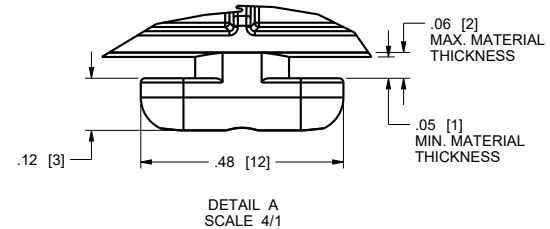

DETAIL A
SCALE 4/1

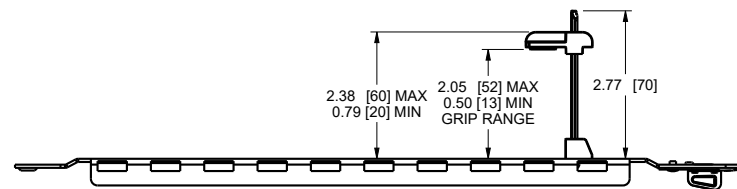



Forward Family

Small Device Mounting & Cable Management

- NOTE(S):
1. ALL DIMENSIONS SHOWN IN FORMAT:
INCHES [MILLIMETERS]
2. ALL SMALL DEVICE MOUNTING AND
CABLE MANAGEMENT SOLUTIONS FIT IN
0.22 [6] X 0.48 [12] (MIN) OBOURND
3. FWD-C-RING CAPACITY IS 3.2 SQ IN. USABLE AREA
4. FWD-D-RING CAPACITY IS 3.4 SQ IN. USABLE AREA

FWD-C-RING

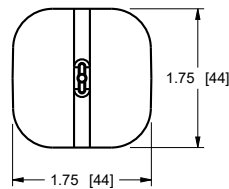
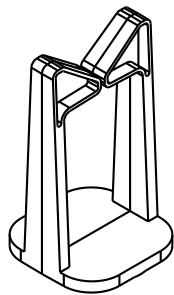
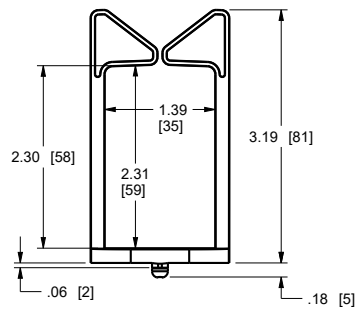
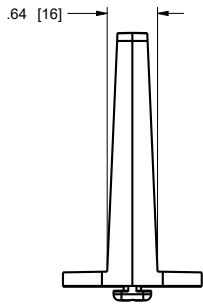
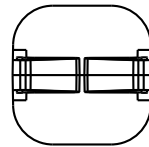

FWD-D-RING

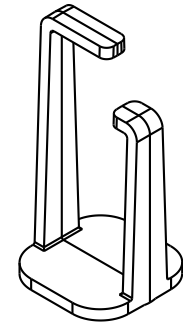
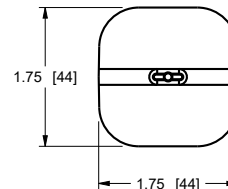
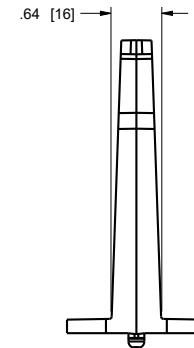
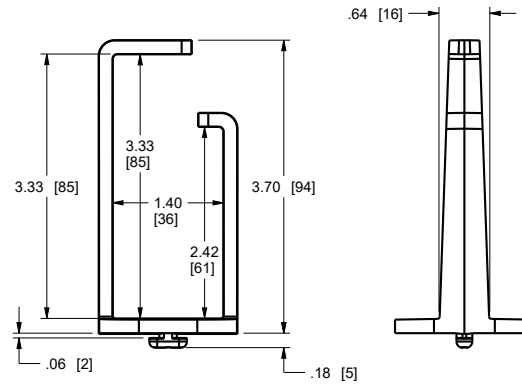
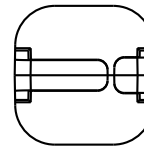



Forward Family

Small Device Mounting & Cable Management

- NOTE(S):
 1. ALL DIMENSIONS SHOWN IN FORMAT:
 INCHES [MILLIMETERS]
 2. ALL SMALL DEVICE MOUNTING AND
 CABLE MANAGEMENT SOLUTIONS FIT IN
 0.22 [6] X 0.48 [12] (MIN) OBOURND

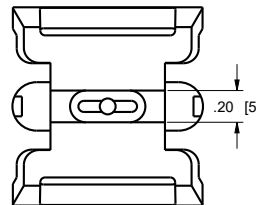
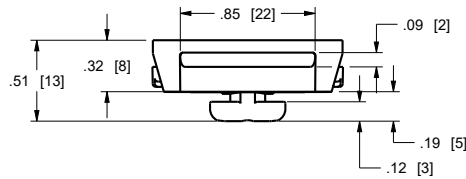
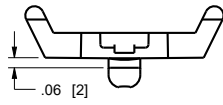
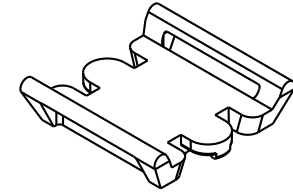
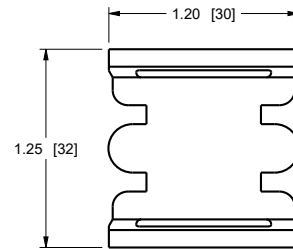



Forward Family

Small Device Mounting & Cable Management

- NOTE(S):
1. ALL DIMENSIONS SHOWN IN FORMAT: INCHES [MILLIMETERS]
 2. ALL SMALL DEVICE MOUNTING AND CABLE MANAGEMENT SOLUTIONS FIT IN 0.22 [6] X 0.48 [12] (MIN) OBOURND

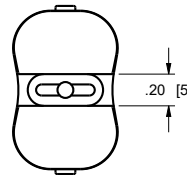
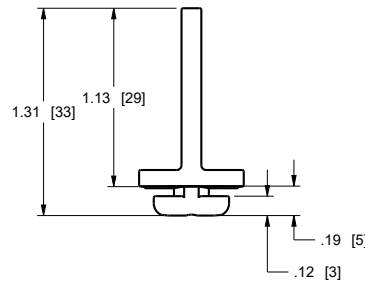
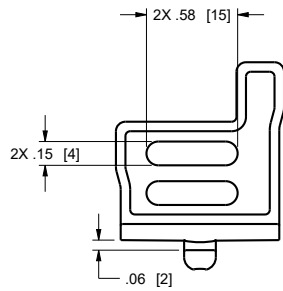
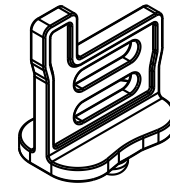
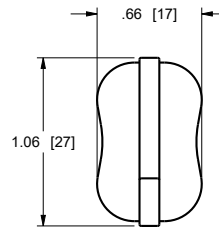

LEGRAND | AV COMMERCIAL BRANDS
C2G | Chief | Da-Lite | Luxul | Middle Atlantic | Vaddio | Wiremold

WHAT GREAT SYSTEMS ARE BUILT ON™ | legrandav.com

USA 800.266.7225 av.middleatlantic.support@legrand.com CANADA 888.766.9770 av.middleatlantic.support@legrand.com

©2023 Legrand AV Inc. 230863 120-00007 Rev B 10/23 Middle Atlantic is a registered trademark of Legrand AV Inc. All other brand names or marks are used for identification purposes and are trademarks of their respective owners. All patents are protected under existing designations. Other patents pending.